

Capacities and Operating Data

Performance Data

Lineal heat release at high fire	Btu/hr/ft	1,000,000	1,250,000	1,500,000	1,750,000	2,000,000	2,250,000	2,500,000
Minimum lineal heat release	Btu/hr/ft	100,000	100,000	100,000	100,000	100,000	100,000	100,000
Turndown ratio		10:1	12.5:1	15:1	17.5:1	20:1	22.5:1	25:1
Flame length	feet [1]	2.7	3.2	3.6	4.0	4.3	4.7	5.0
Pilot pressure/heat release	"w.c.* [2] / Btu/hr	5-8" w.c. / 40,000 Btu/hr						
Combustion air flow	SCFM	250	313	375	438	500	563	625
Air pressure at burner inlet	("w.c.) [3]	2.3	3.6	5.1	7.0	9.1	11.5	14.2
Air pressure at burner test connection	("w.c.)*	2.1	3.3	4.7	6.4	8.3	10.5	13.0
Fuel pressure at burner inlet (natural gas)	("w.c.) [3]	8.5	13.3	19.2	26.1	34.1	43.2	53.3
Fuel pressure at burner test connection (natural gas)	("w.c.)*	7.4	11.5	16.6	22.5	29.4	37.3	46.0
NOx emissions [4]	ppm @ 3% O ₂	<25 ppm corrected to 3% O ₂ dry						
CO emissions [4]	ppm @ 3% O ₂	<250 ppm corrected to 3% O ₂ dry						

[1] Flame length is based on 50% excess combustion air. Flame length will vary depending on various application parameters (e.g. passing air stream velocity, oxygen content, and combustion air preheat temperature)

[2] At inlet of adjustable pilot orifice.

[3] Air and gas DP is differential over system static pressure.

[4] Emissions stated are not guaranteed. Actual emission performance may vary. Contact Maxon for specific application details.

*Differential pressures measured at burner test connections. Air and gas DP is differential over system static pressure.

Operating Environment

Variable		Minimum	Maximum
Inlet Combustion Air Temp.	°F	Ambient	200
Inlet Combustion Air O ₂ Level	% O ₂	20.8	20.8
Air Stream Cross Velocity	ft/min	0	3000
Air Stream Axial Velocity	ft/min	0	4000
Upstream Air Temperature	°F	See Chart Below	
Downstream Air Temperature	°F		
Process Air Stream O ₂ Level	% O ₂	4	21

The burner can operate in a variety of environments. Typical operating environments, limits on their variables, and notes concerning operation of the burner are presented at left.

It is important to note that inlet combustion variables such as O₂ level and combustion air temperature will change air pressure requirements and/or maximum firing capacity.

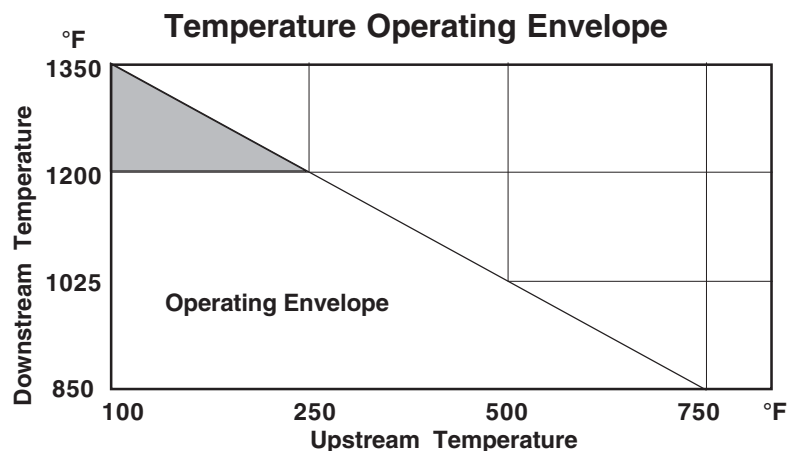

Consult Maxon for operation in shaded region. Ability to operate in shaded region is dependent upon operating conditions.

Distributed by:



888.858.3647 | relevantsolutions.com

Capacities and Operating Data

Natural Gas Fuel/Air Settings

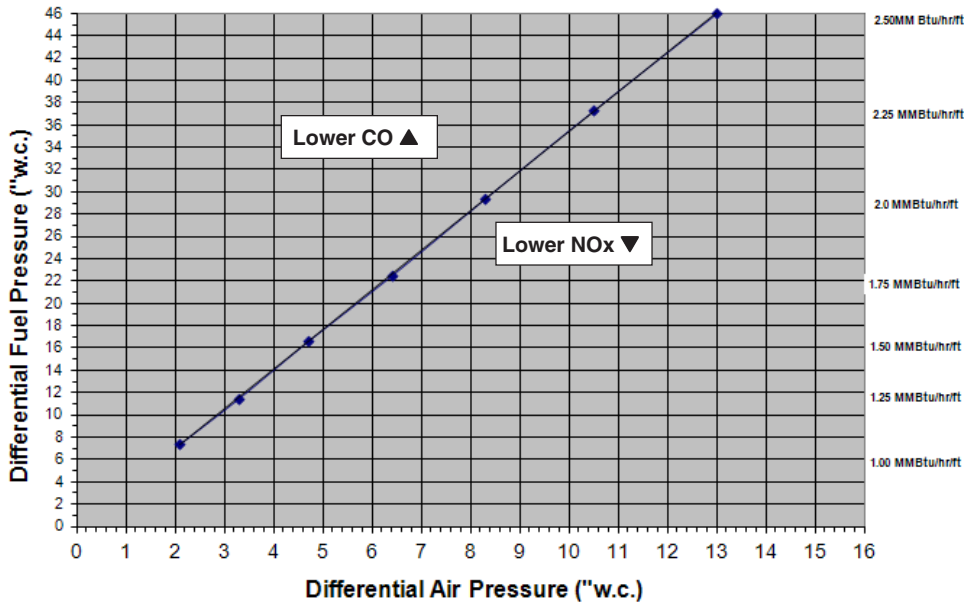

NOTE: Pressure measured at burner test connections; refer to inlet pressure requirements for fan sizing

Propane Fuel/Air Settings

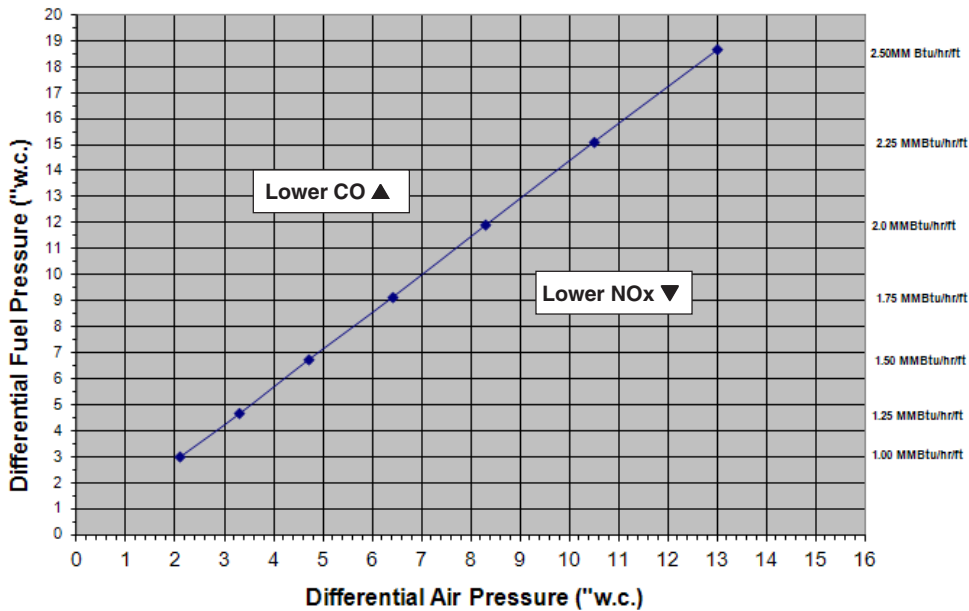

NOTE: Pressure measured at burner test connections; refer to inlet pressure requirements for fan sizing

Dimensions *(in inches)*
Straight Burner Sections

.5 ft. burner - end inlet

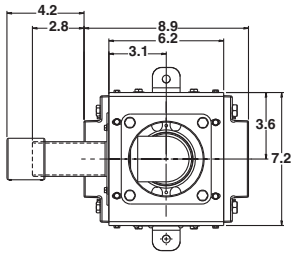

1 ft. burner - end inlet

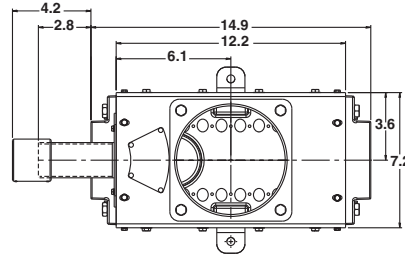

1.5 ft. burner - end inlet

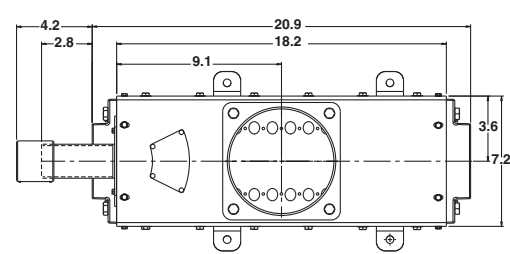

2 ft. burner - back inlet

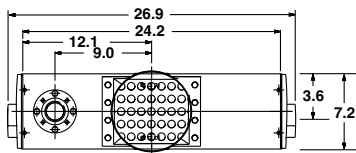

3 ft. burner - back inlet

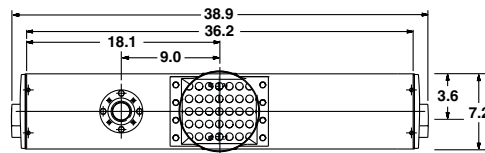

4 ft. burner - back inlet

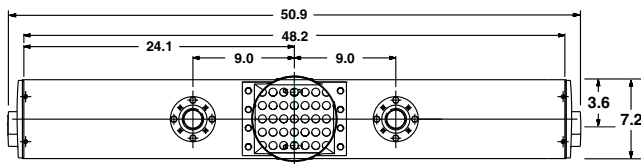

5 ft. burner - back inlet

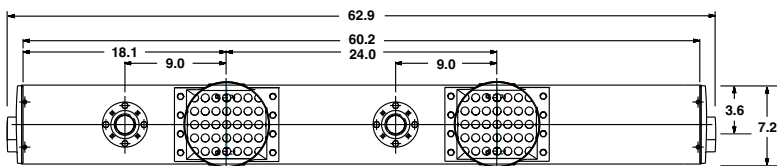

6 ft. burner - back inlet

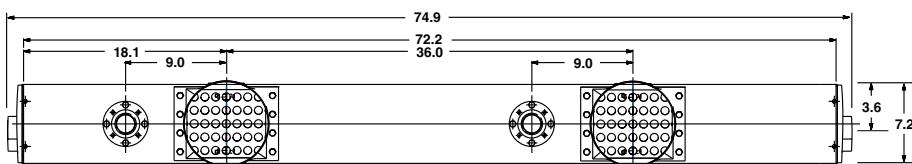

Dimensions *(in inches)* Straight Burner Sections

7 ft. burner - back inlet

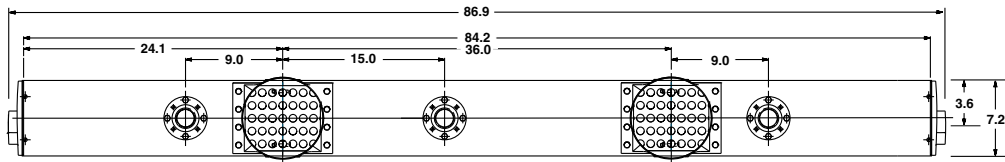

8 ft. burner - back inlet

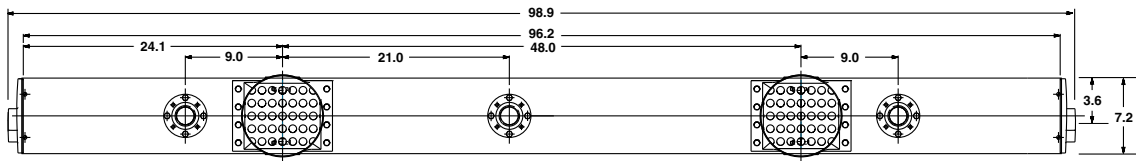

9 ft. burner - back inlet

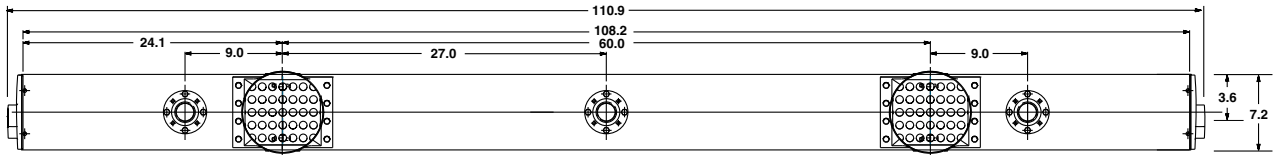

Dimensions *(in inches)*
2 ft. back inlet grid sections

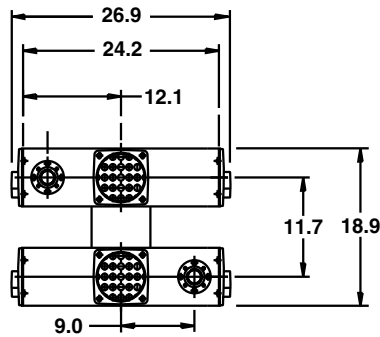

2 BI XF GRD with 12" span

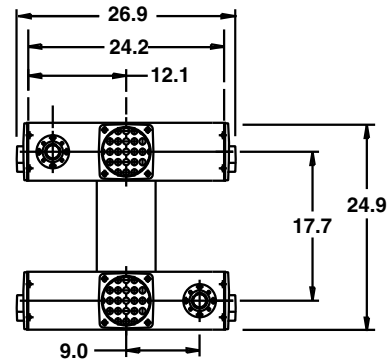

2 BI XF GRD with 18" span

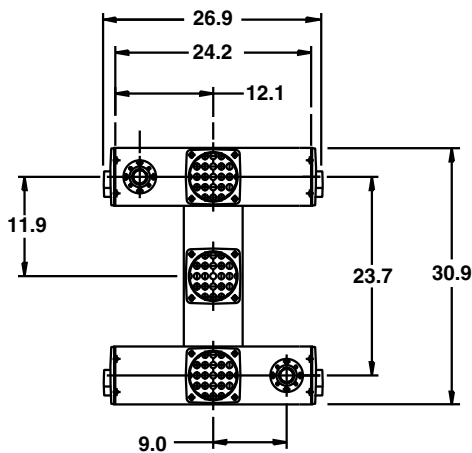

2 BI XF GRD with 24" span

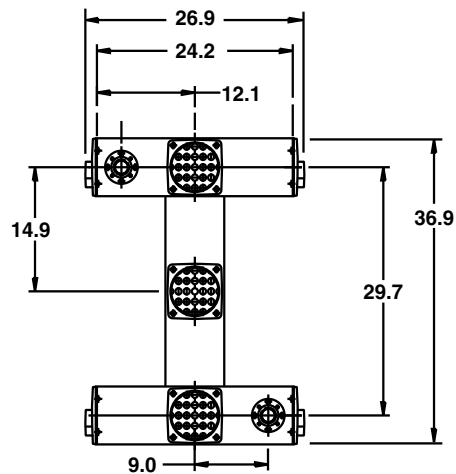

2 BI XF GRD with 30" span

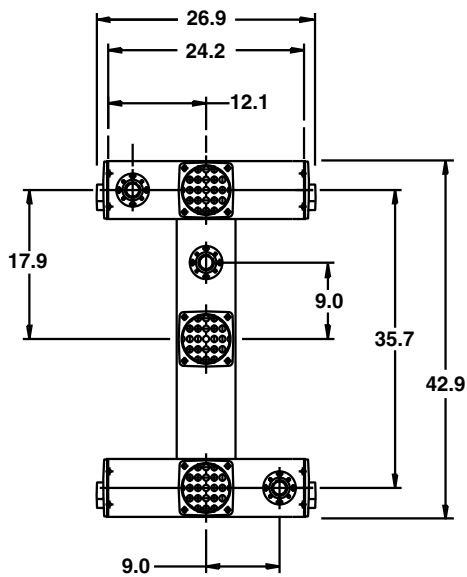

2 BI XF GRD with 36" span

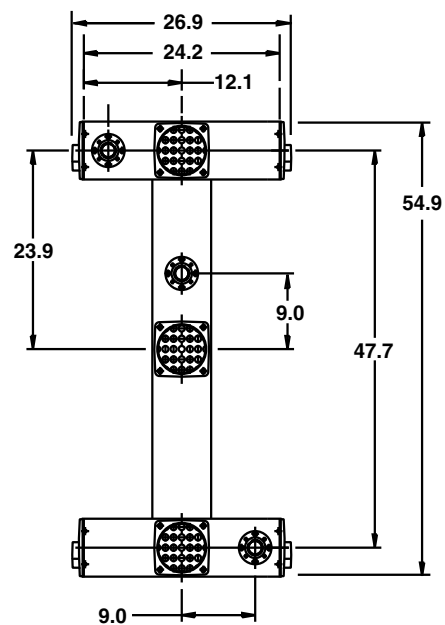

2 BI XF GRD with 48" span

Dimensions *(in inches)*
3 ft. back inlet grid sections

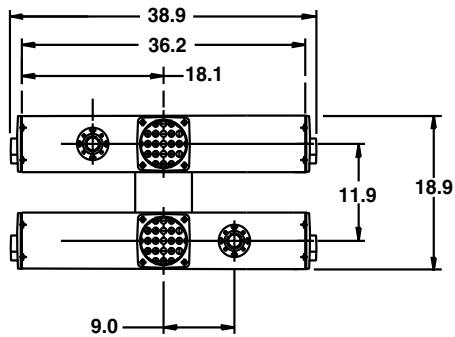

3 BI XF GRD with 12" span

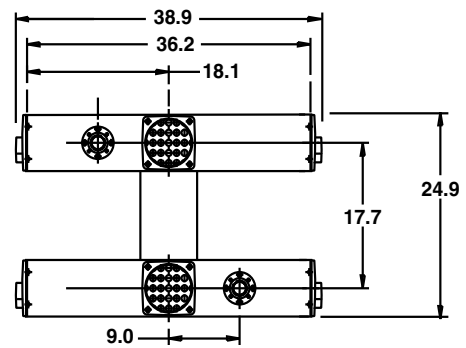

3 BI XF GRD with 18" span

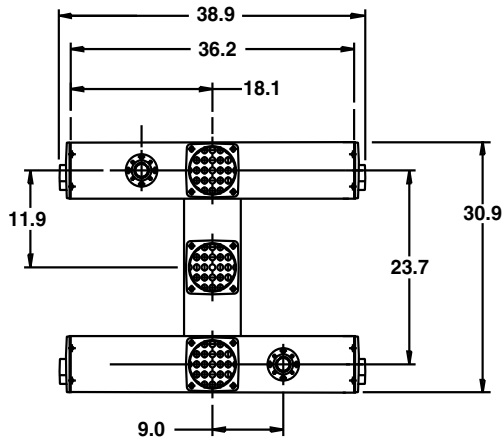

3 BI XF GRD with 24" span

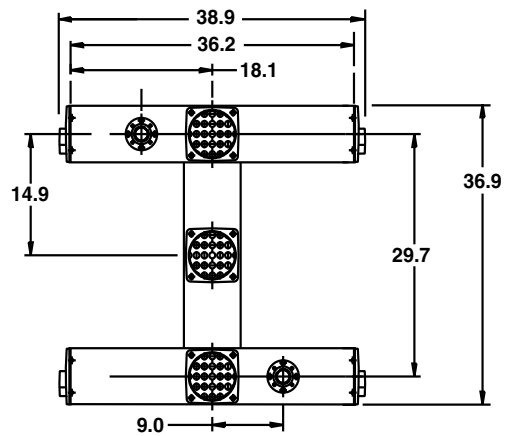

3 BI XF GRD with 30" span

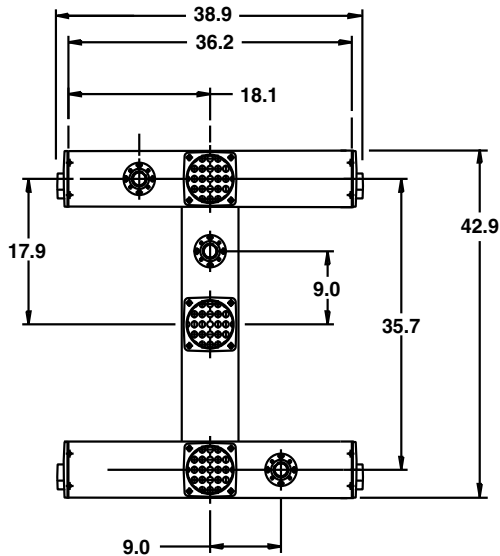

3 BI XF GRD with 36" span

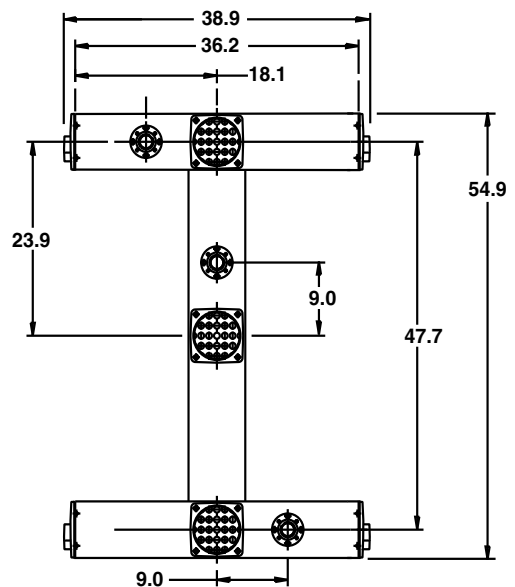

3 BI XF GRD with 48" span

Dimensions *(in inches)*
4 ft. back inlet grid sections

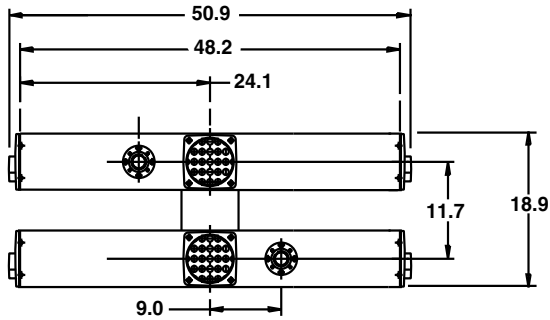

4 BI XF GRD with 12" span

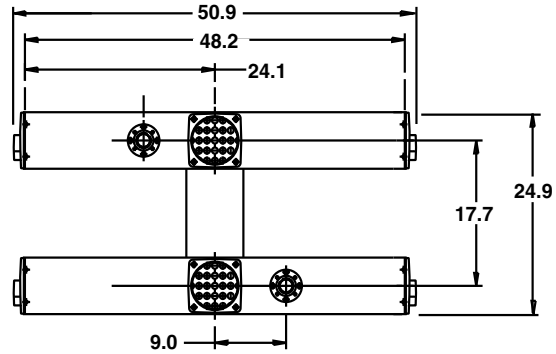

4 BI XF GRD with 18" span

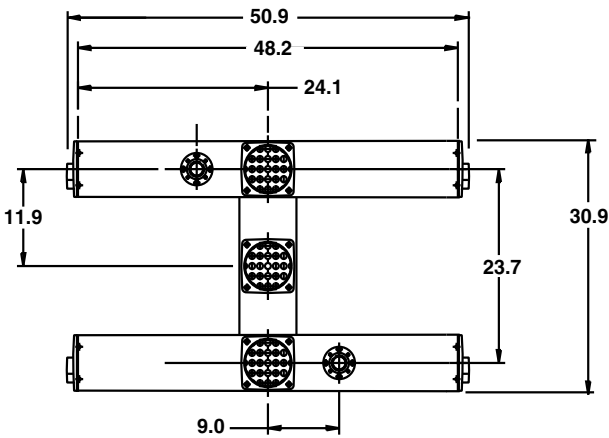

4 BI XF GRD with 24" span

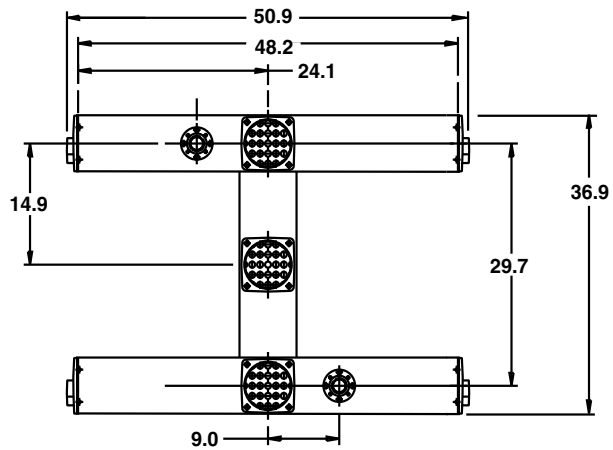

4 BI XF GRD with 30" span

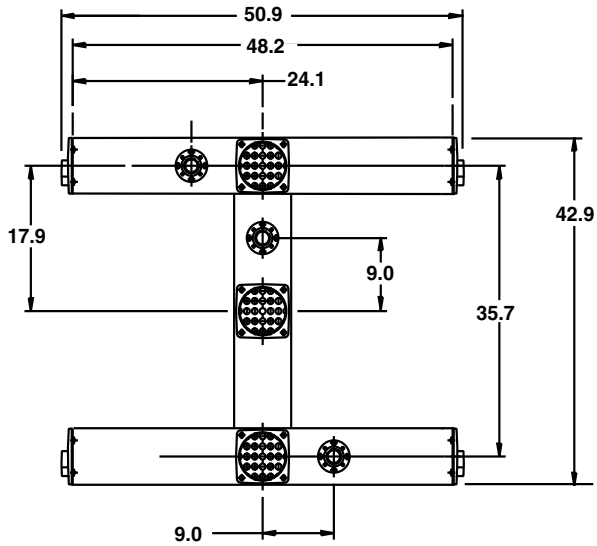

4 BI XF GRD with 36" span

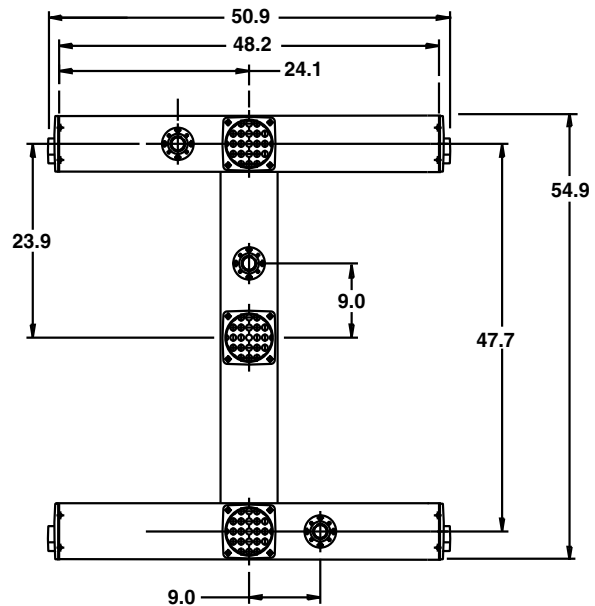

4 BI XF GRD with 48" span

Dimensions *(in inches)*
5 ft. back inlet grid sections

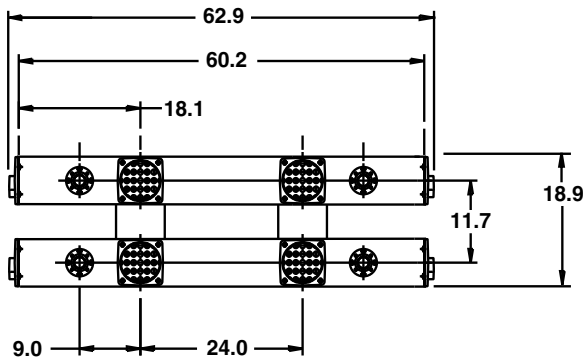

5 BI XF GRD with 12" span

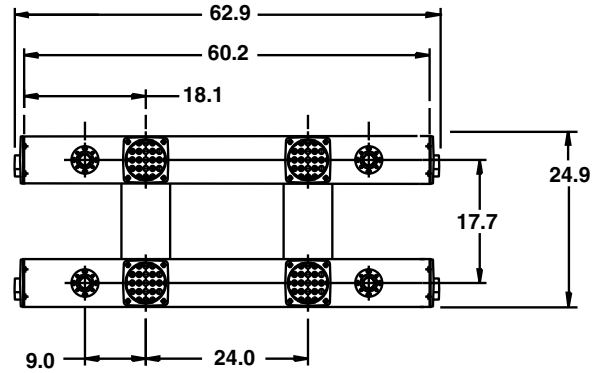

5 BI XF GRD with 18" span

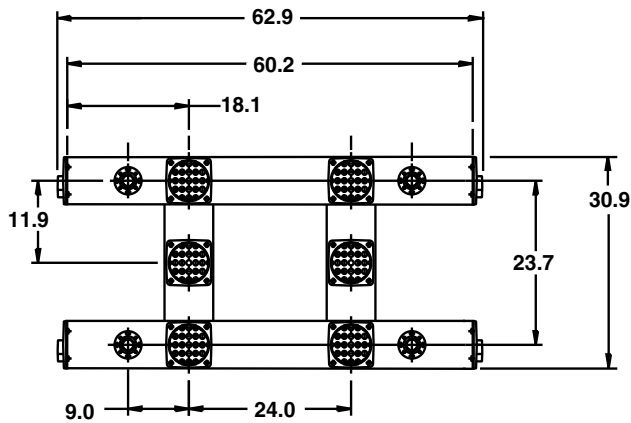

5 BI XF GRD with 24" span

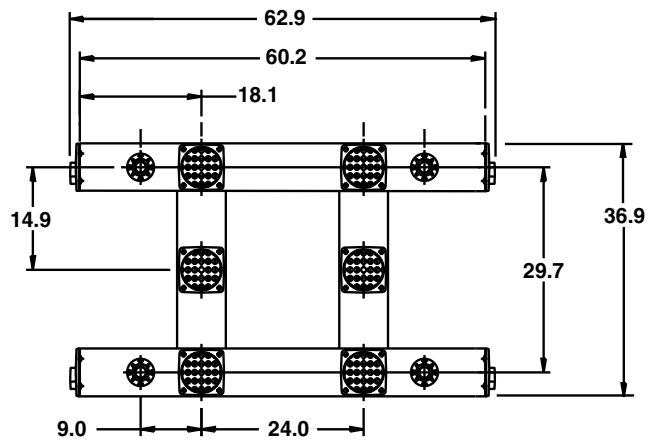

5 BI XF GRD with 30" span

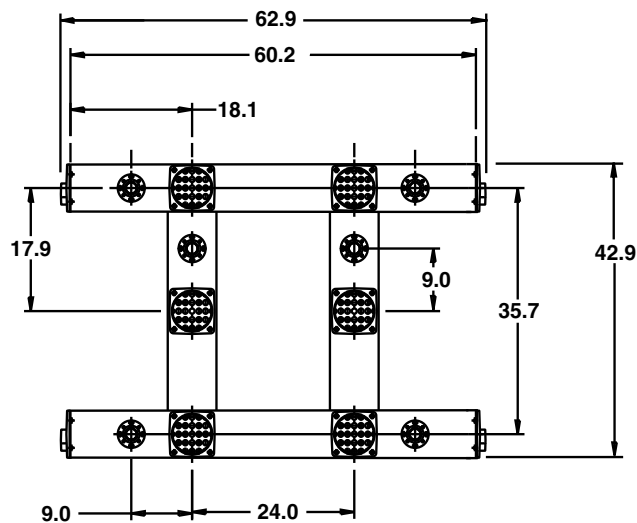

5 BI XF GRD with 36" span

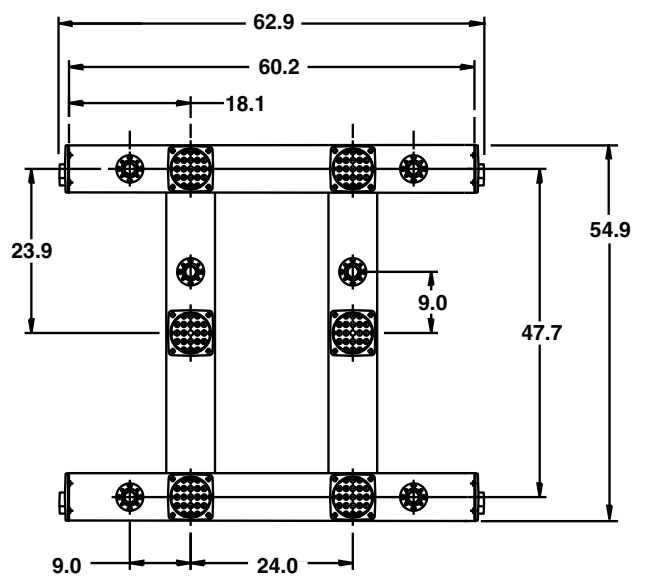

5 BI XF GRD with 48" span

Dimensions *(in inches)* 6 ft. back inlet grid sections

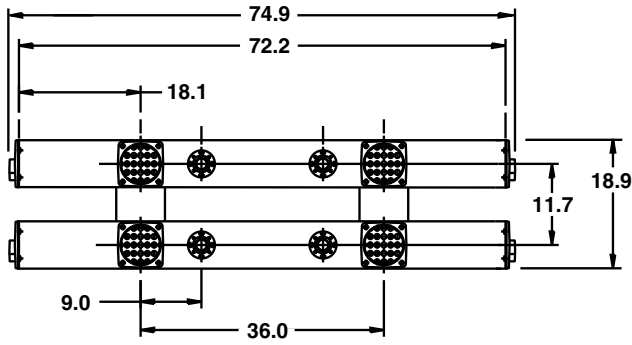

6 BI XF GRD with 12" span

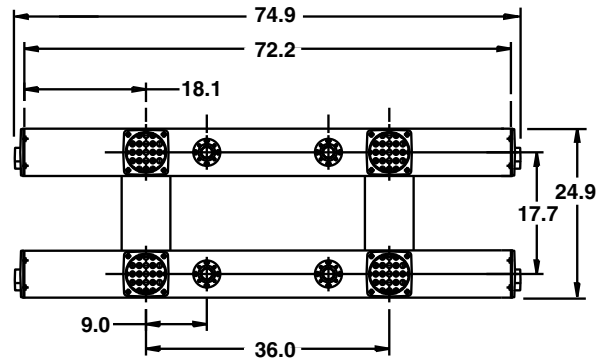

6 BI XF GRD with 18" span

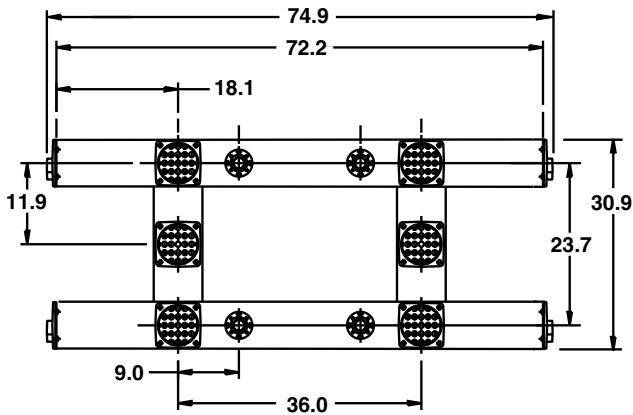

6 BI XF GRD with 24" span

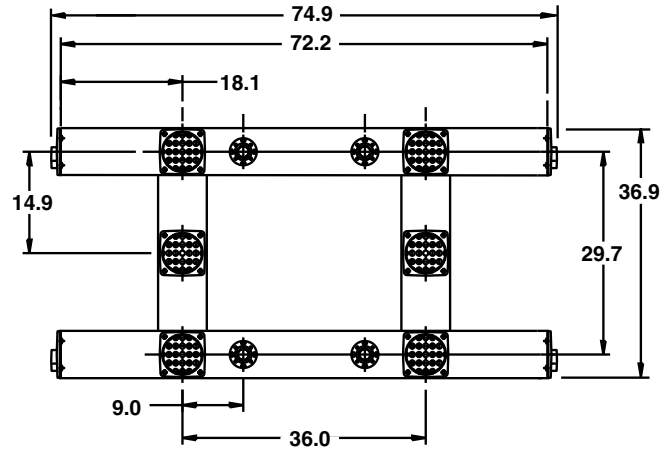

6 BI XF GRD with 30" span

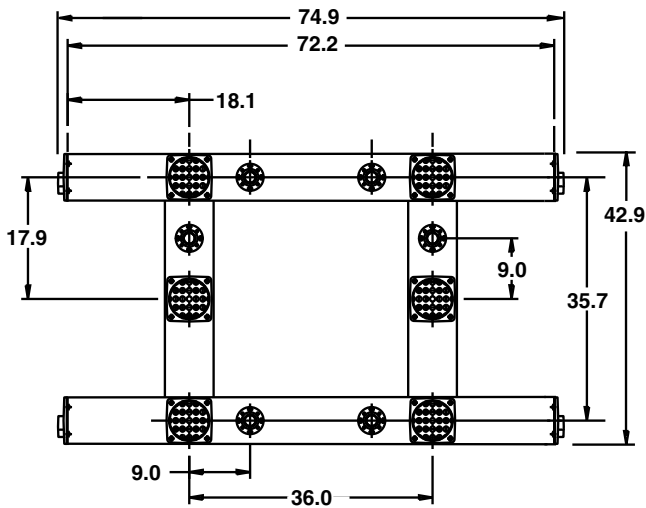

6 BI XF GRD with 36" span

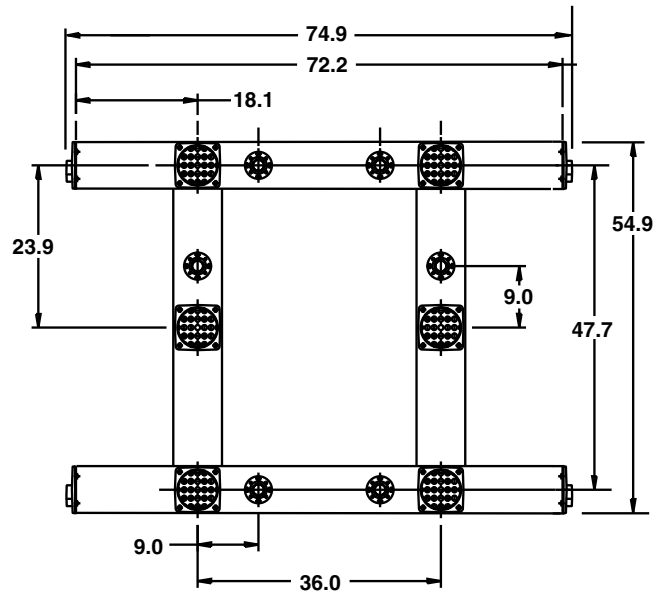

6 BI XF GRD with 48" span

Dimensions *(in inches)*
7 ft. back inlet grid sections

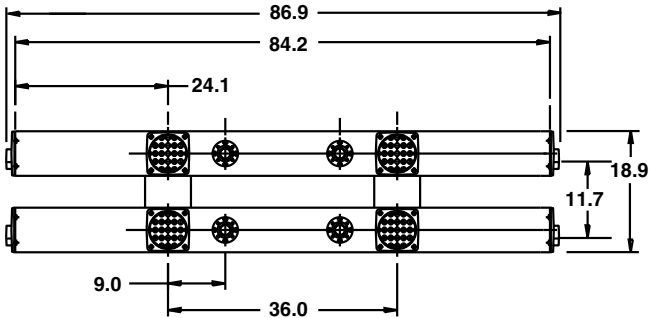

7 BI XF GRD with 12" span

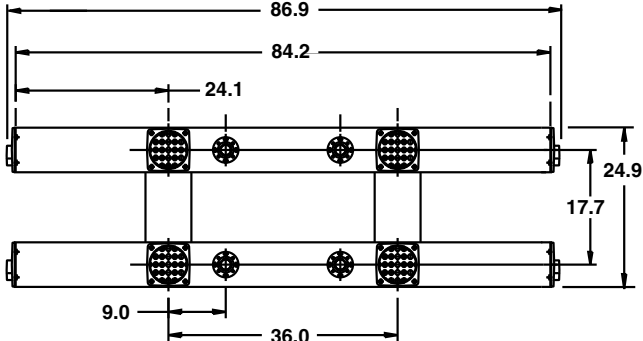

7 BI XF GRD with 18" span

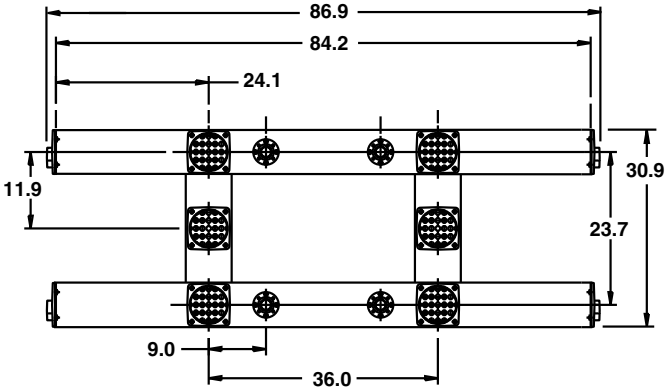

7 BI XF GRD with 24" span

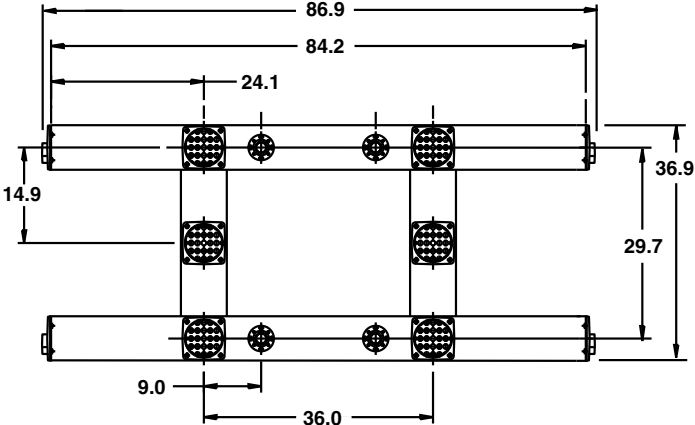

7 BI XF GRD with 30" span

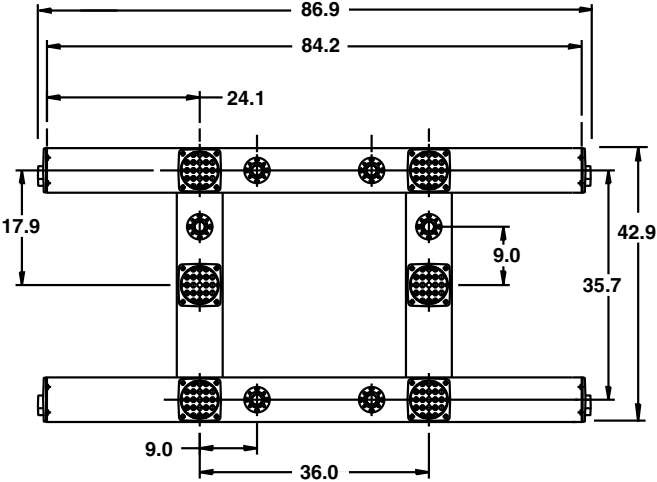

7 BI XF GRD with 36" span

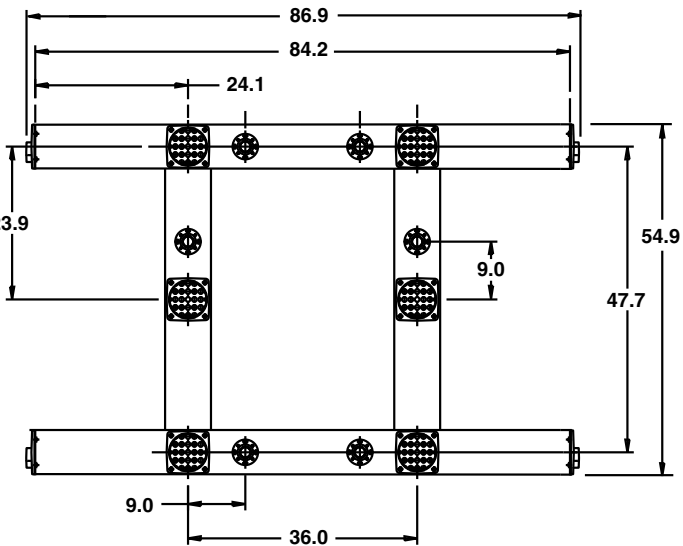

7 BI XF GRD with 48" span

Dimensions *(in inches)* 8 ft. back inlet grid sections

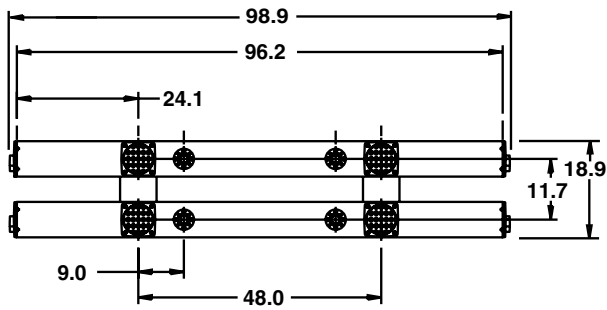

8 BI XF GRD with 12" span

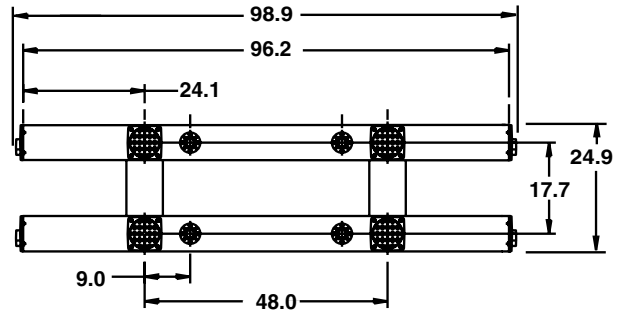

8 BI XF GRD with 18" span

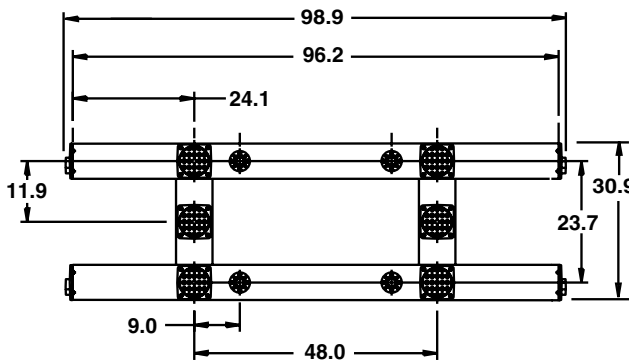

8 BI XF GRD with 24" span

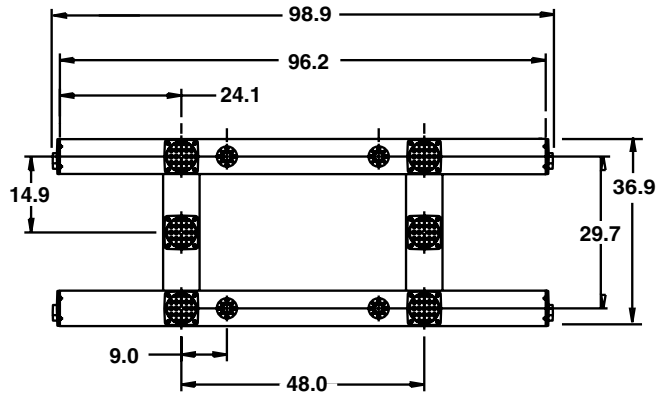

8 BI XF GRD with 30" span

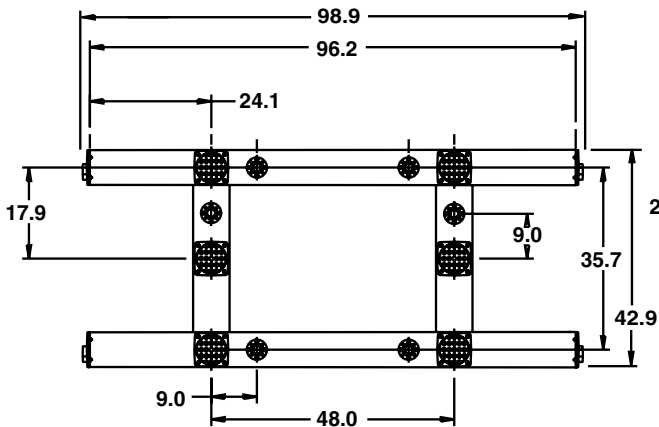

8 BI XF GRD with 36" span

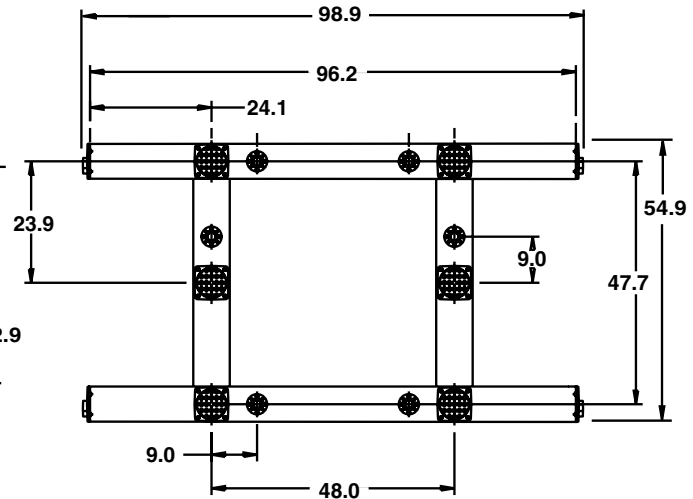

8 BI XF GRD with 48" span

Dimensions *(in inches)*
9 ft. back inlet grid sections

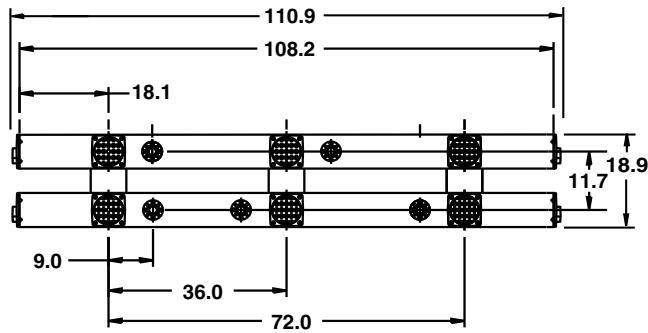

9 BI XF GRD with 12" span

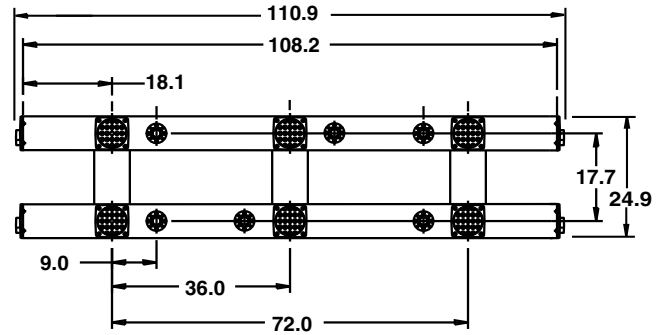

9 BI XF GRD with 18" span

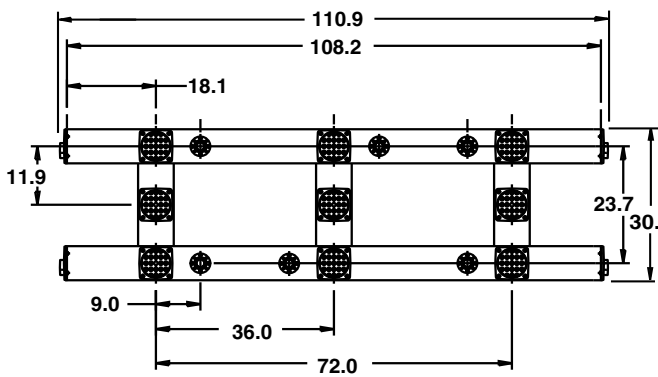

9 BI XF GRD with 24" span

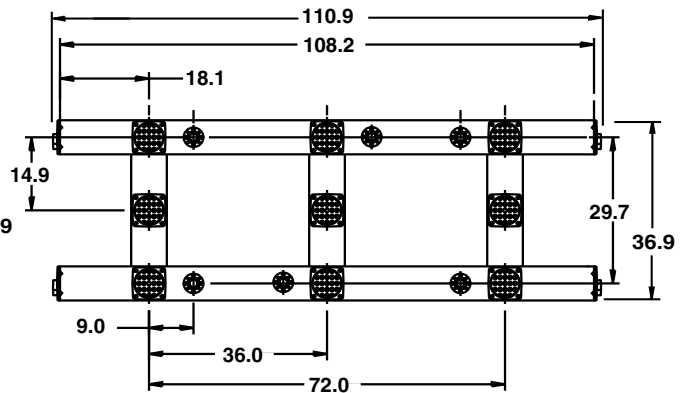

9 BI XF GRD with 30" span

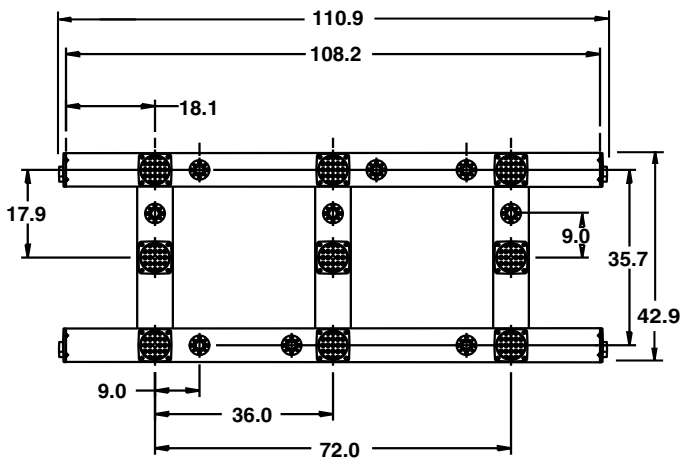

9 BI XF GRD with 36" span

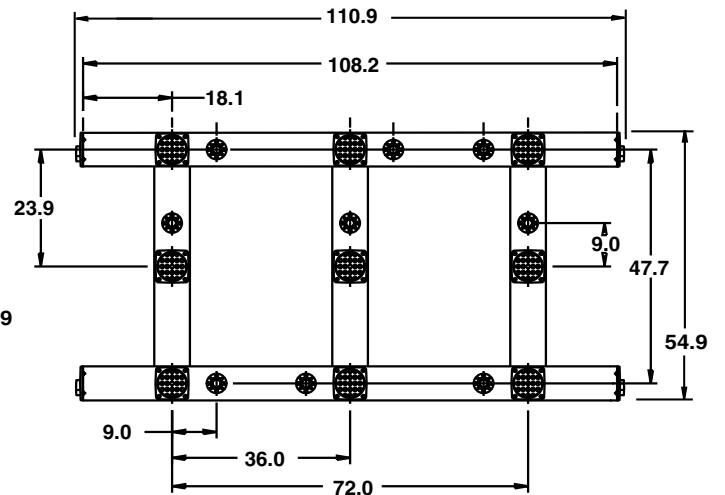

9 BI XF GRD with 48" span

Dimensions *(in inches)*

Horizontal spacing of CROSSFIRE® ladders

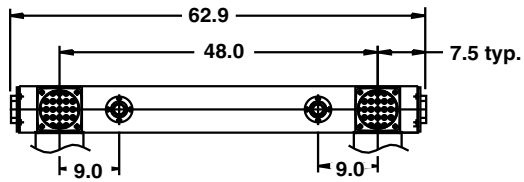

4 ft. CROSSFIRE® Ladder

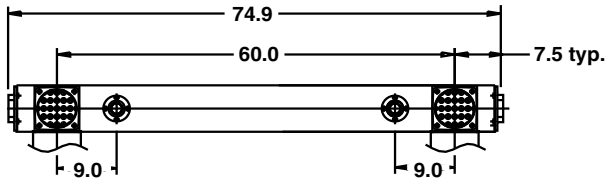

5 ft. CROSSFIRE® Ladder

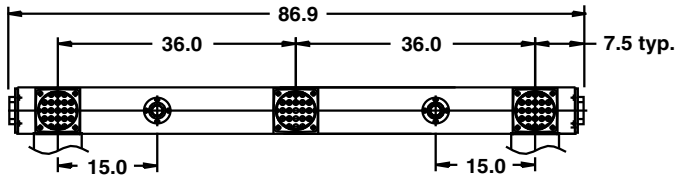

6 ft. CROSSFIRE® Ladder

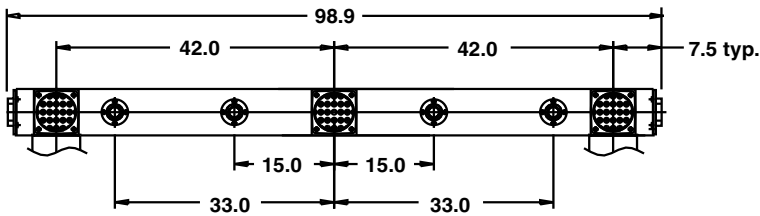

7 ft. CROSSFIRE® Ladder

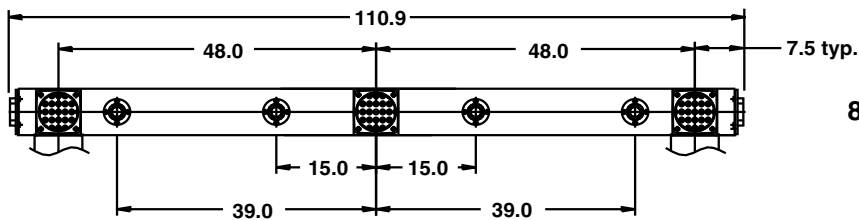

8 ft. CROSSFIRE® Ladder

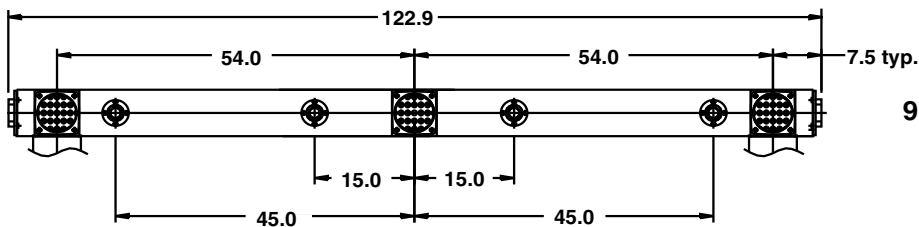

9 ft. CROSSFIRE® Ladder

Dimensions *(in inches)*

Vertical spacing of CROSSFIRE® ladders

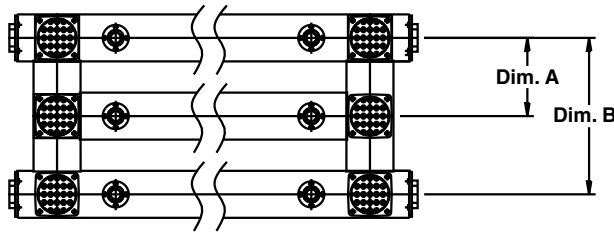

Cross Member		Dim. A (inches)	Dim. B (inches)
Designation	Description		
112	Qty. 1 - 12" spacing	12	24
118	Qty. 1 - 18" spacing	18	36
124	Qty. 1 - 24" spacing	24	48
130	Qty. 1 - 30" spacing	30	60

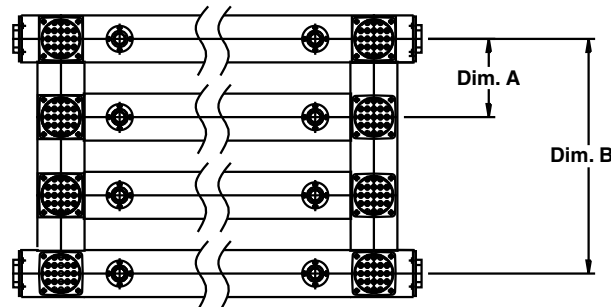

Cross Member		Dim. A (inches)	Dim. B (inches)
Designation	Description		
212	Qty. 2 - 12" spacing	12	36
218	Qty. 2 - 18" spacing	18	54
224	Qty. 2 - 24" spacing	24	72
230	Qty. 2 - 30" spacing	30	90

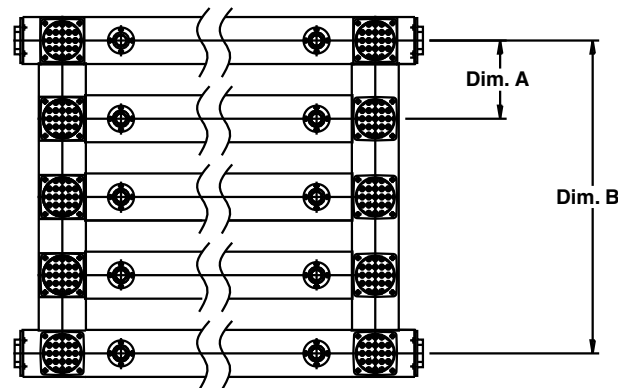

Cross Member		Dim. A (inches)	Dim. B (inches)
Designation	Description		
312	Qty. 3 - 12" spacing	12	48
318	Qty. 3 - 18" spacing	18	72
324	Qty. 3 - 24" spacing	24	96
330	Qty. 3 - 30" spacing	30	120

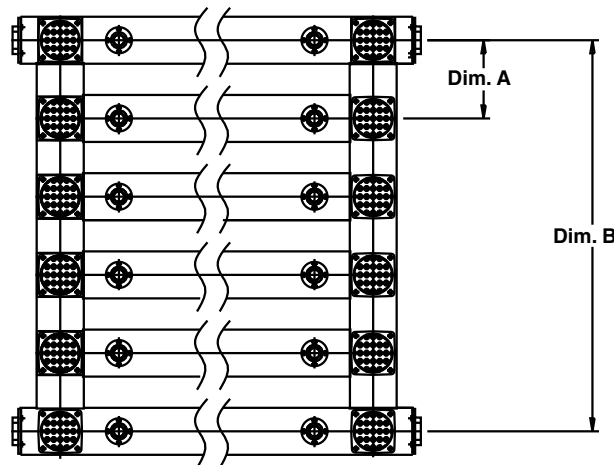

Cross Member		Dim. A (inches)	Dim. B (inches)
Designation	Description		
412	Qty. 4 - 12" spacing	12	60
418	Qty. 4 - 18" spacing	18	90
424	Qty. 4 - 24" spacing	24	120
430	Qty. 4 - 30" spacing	30	150

See page 5616 for horizontal spacing of CROSSFIRE® ladders

Notes